



The Bose® Lifestyle® 5 Music System

Owner's Guide

October 22, 2001

AM251774_03_V.pdf

 **WARNING:** To reduce the risk of fire or electric shock, do not expose the system to rain or moisture.

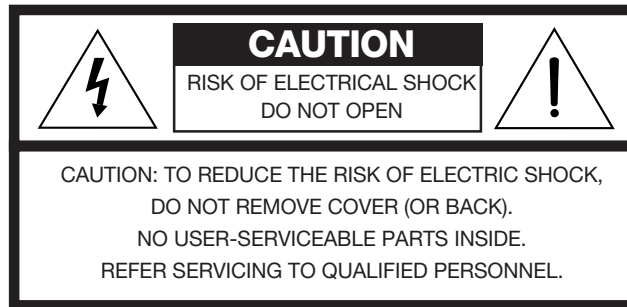

These CAUTION marks may be located on the back panel and bottom of your Lifestyle® music center and the bottom panel of your Acoustimass® module:



The lightning flash with arrowhead symbol, within an equilateral triangle, is intended to alert the user to the presence of uninsulated dangerous voltage within the system enclosure that may be of sufficient magnitude to constitute a risk of electric shock.



The exclamation point within an equilateral triangle, as marked on the system, is intended to alert the user to the presence of important operating and maintenance instructions in this owner's guide.

 **CAUTION:** To prevent electric shock, match wide blade of plug to wide slot, insert fully.

Class 1 laser product



This compact disc player is classified as a CLASS 1 LASER product. The CLASS 1 LASER PRODUCT label is located on the bottom of the unit.

 **CAUTION:** Use of controls or adjustments or performance of procedures other than those specified herein may result in hazardous radiation exposure. The compact disc player should not be adjusted or repaired by anyone except properly qualified service personnel.

Class B emissions limits

This Class B digital apparatus meets all requirements of the Canadian Interference-Causing Equipment Regulations.

Batteries

Please dispose of used batteries properly, following any local regulations. Do not incinerate.

Additional safety information

See the additional instructions on the *Important Safety Information* page enclosed with this owner's guide.

Please read this owner's guide

Please take the time to follow this owner's guide carefully. It will help you set up and operate your system properly, and enjoy all of its advanced features. Save your owner's guide for future reference.

Important Safety Instructions

- 1. Read these instructions** – for all components before using this product.
- 2. Keep these instructions** – for future reference.
- 3. Heed all warnings** – on the product and in the owner's guide.
- 4. Follow all instructions.**
- 5. Do not use this apparatus near water or moisture** – Do not use this product near a bathtub, washbowl, kitchen sink, laundry tub, in a wet basement, near a swimming pool, or anywhere else that water or moisture are present.
- 6. Clean only with a dry cloth** – and as directed by Bose® Corporation. Unplug this product from the wall outlet before cleaning.
- 7. Do not block any ventilation openings. Install in accordance with the manufacturer's instructions** – To ensure reliable operation of the product and to protect it from overheating, put the product in a position and location that will not interfere with its proper ventilation. For example, do not place the product on a bed, sofa, or similar surface that may block the ventilation openings. Do not put it in a built-in system, such as a bookcase or a cabinet that may keep air from flowing through its ventilation openings.
- 8. Do not install near any heat sources, such as radiators, heat registers, stoves or other apparatus (including amplifiers) that produce heat.**
- 9. Do not defeat the safety purpose of the polarized or grounding-type plug. A polarized plug has two blades with one wider than the other. A grounding-type plug has two blades and a third grounding prong. The wider blade or third prong are provided for your safety. If the provided plug does not fit in your outlet, consult an electrician for replacement of the obsolete outlet.**
- 10. Protect the power cord from being walked on or pinched, particularly at plugs, convenience receptacles, and the point where they exit from the apparatus.**
- 11. Only use attachments/accessories specified by the manufacturer.**
- 12. Use only with the cart, stand, tripod, bracket or table specified by the manufacturer or sold with the apparatus. When a cart is used, use caution when moving the cart/apparatus combination to avoid injury from tip-over.**
- 13. Unplug this apparatus during lightning storms or when unused for long periods of time** – to prevent damage to this product.
- 14. Refer all servicing to qualified service personnel. Servicing is required when the apparatus has been damaged in any way: such as power-supply cord or plug is damaged; liquid has been spilled or objects have fallen into the apparatus; the apparatus has been exposed to rain or moisture, does not operate normally, or has been dropped** – Do not attempt to service this product yourself. Opening or removing covers may expose you to dangerous voltages or other hazards. Please call Bose to be referred to an authorized service center near you.
- 15. To prevent risk of fire or electric shock, avoid overloading wall outlets, extension cords, or integral convenience receptacles.**
- 16. Do not let objects or liquids enter the product** – as they may touch dangerous voltage points or short-out parts that could result in a fire or electric shock.
- 17. See product enclosure for safety related markings.**

Information about products that generate electrical noise

If applicable, this equipment has been tested and found to comply with the limits for a Class B digital device, pursuant to Part 15 of the FCC rules. These limits are designed to provide reasonable protection against harmful interference in a residential installation. This equipment generates, uses, and can radiate radio frequency energy and, if not installed and used in accordance with the instructions, may cause harmful interference to radio communications. However, this is no guarantee that interference will not occur in a particular installation. If this equipment does cause harmful interference to radio or television reception, which can be determined by turning the equipment off and on, you are encouraged to try to correct the interference by one or more of the following measures:

- Reorient or relocate the receiving antenna.
- Increase the separation between the equipment and receiver.
- Connect the equipment to an outlet on a different circuit than the one to which the receiver is connected.
- Consult the dealer or an experienced radio/TV technician for help.

Note: *Unauthorized modification of the receiver or radio remote control could void the user's authority to operate this equipment.*

This product complies with the Canadian ICES-003 Class B specifications.



Important Safety Instructions

- 18. Use proper power sources** – Plug the product into a proper power source, as described in the operating instructions or as marked on the product.
- 19. Avoid power lines** – Use extreme care when installing an outside antenna system to keep from touching power lines or circuits, as contact with them may be fatal. Do not install external antennas near overhead power lines or other electric light or power circuits, nor where an antenna can fall into such circuits or power lines.
- 20. Ground all outdoor antennas** – If an external antenna or cable system is connected to this product, be sure the antenna or cable system is grounded. This will provide some protection against voltage surges and built-up static charges.
- Section 810 of the National Electrical Code ANSI/NFPA No. 70 provides information with respect to proper grounding of the mast and supporting structure, grounding of the lead-in wire to an antenna discharge unit, size of grounding conductors, location of antenna-discharge unit, connection to grounding electrodes, and requirements for the ground electrode. Refer to the antenna grounding illustration on this page.

Antenna grounding

Example of antenna grounding as per National Electrical Code, ANSI/NFPA 70.

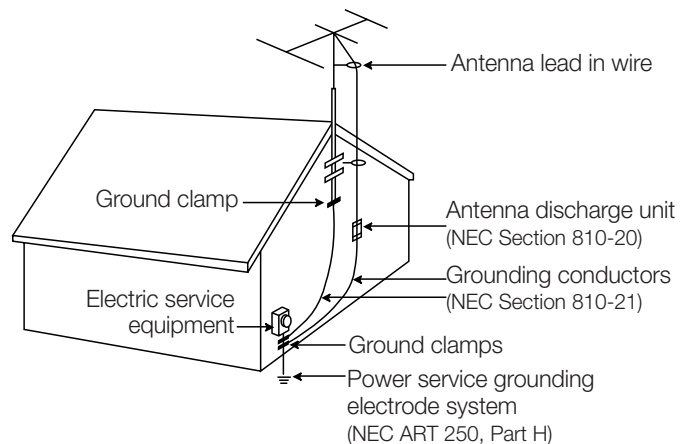

Note to CATV system installer

This reminder is provided to call the CATV system installer's attention to Article 820-40 of the NEC (of USA) that provides guidelines for proper grounding. In particular, it specifies that the cable ground shall be connected to the grounding system of the building, as close to the point of cable entry as is practical.

Where to find...

Setting Up

- Before you begin 4
- Unpacking the carton 5
- Select the locations for your Lifestyle® 5 music system 6
- Connect the speakers and Lifestyle® music center 8
- Connecting other components to the Lifestyle® 5 music system 11
- Connect the antennas 12
- Attach the wire cover 12
- Set up the remote control 13
- Set radio channel spacing for dual voltage and 120V systems 13
- Turn on the music center 13

Operating Your Lifestyle® 5 music system

- The music center display 14
- The system controls 14
- The music center controls 15
- The Lifestyle® remote control 15
- Listening to the radio 16
- Listening to a CD 17
- Using the system with an external component 17

Maintaining Your Lifestyle® 5 music system

- Fine-tuning your system 18
- Changing the house code settings 19
- Adding speakers 20
- Troubleshooting 21
- Warranty period 22
- Customer service 22
- Cleaning the Lifestyle® 5 music system 22

Product Information

- Technical information 23
- Accessories 23

Index 24

Bose® Corporation inside back cover

For your records

Serial numbers are located on the bottom of the music center and the bottom panel of the Acoustimass® module.

Music center serial number: _____

Acoustimass module serial number: _____

Dealer name: _____

Dealer phone: _____ Purchase date: _____

We suggest you keep your sales slip and warranty card together with this owner's guide.

Before you begin

Thank you for purchasing the Bose® Lifestyle® 5 music system. This complete audio system offers superb sound, elegance, technology, and simplicity for music and home entertainment.

Your system includes:

- A Lifestyle® music center with built-in AM/FM radio and compact disc (CD) player
- Inputs for a video sound source, an auxiliary source, and a tape deck
- Powered Acoustimass® speakers with a hide-away Acoustimass module
- An easy-to-use remote control

Unpacking the carton

Carefully unpack your system. Save all packing materials for possible future use. The original packing materials provide the safest way to transport your Lifestyle® 5 music system. If any part of the product appears damaged, do not attempt to use the system. Notify Bose® or your authorized Bose dealer immediately.

Check to be sure your Lifestyle® 5 music system contains the parts identified in Figure 1.

Note: Find the serial numbers on the bottom panel of the Acoustimass® module and the bottom of the music center. Then write them on your warranty card and in the spaces provided on page 3.

WARNING: The Acoustimass module weighs 33 pounds (15 kg). Use good lifting practice to avoid injury.

WARNING: To avoid danger of suffocation, keep the plastic bags out of the reach of children.

Figure 1

What comes with your Lifestyle® 5 music system:

- Lifestyle® music center
- AC power (mains) pack*
- Wire cover
- FM antenna
- AM loop antenna
- AM antenna base
- Remote control
- 3 AA batteries
- Acoustimass module
- 2 cube speaker arrays
- AC power (mains) cord*
- Audio input cable
- 2 speaker cables
- 4 self-adhesive rubber feet (for the Acoustimass module)
- Lifestyle® system CD

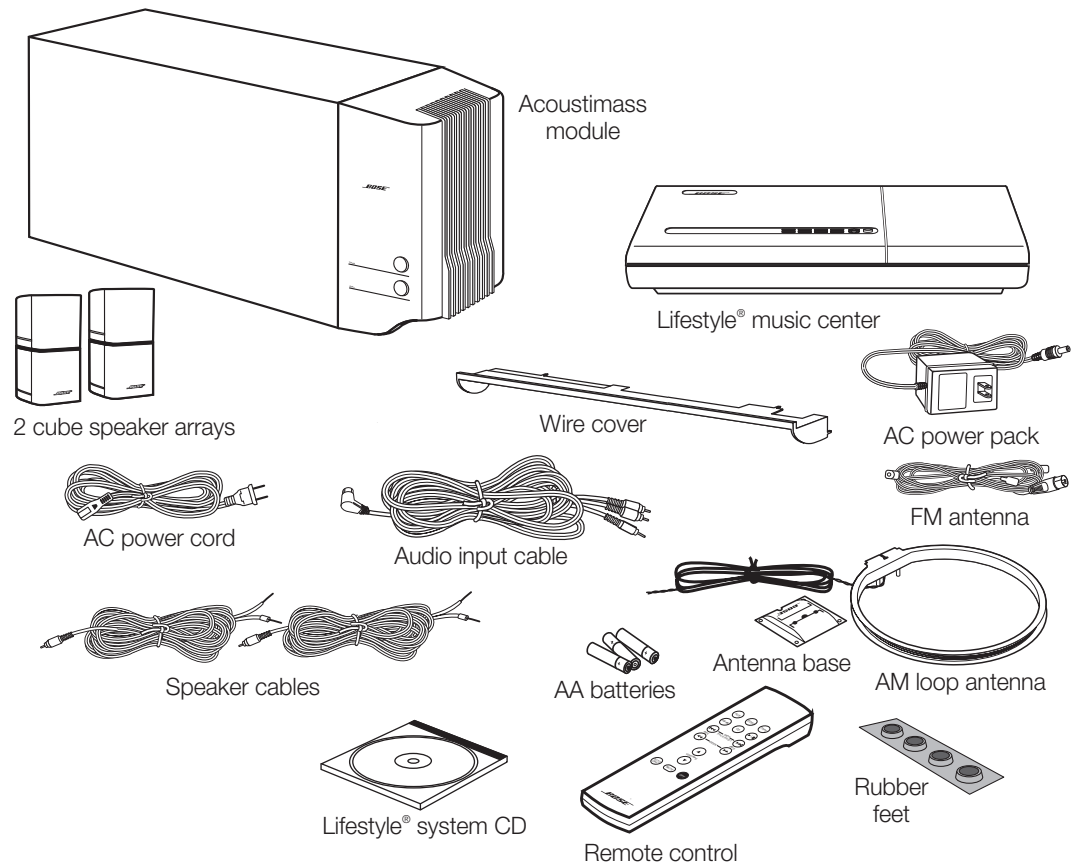

* Power cord and pack shown above are USA/Canada versions.

Dual voltage systems include 1 power cord, 1 adapter , and 2 power packs.

The power cords and packs for Europe, UK/Singapore, and Australia are shown below.



Select the locations for your Lifestyle® 5 music system

When you place your speakers according to the guidelines below, a combination of reflected and direct sound provides a good stereo image virtually everywhere in the room. You may experiment with the placement and orientation of the cubes and the Acoustimass® module to produce the sound most pleasing to you.

To adjust your system for the characteristics of your listening room, see “Fine-tuning your system” on page 23.

Speaker locations

Follow these guidelines to select locations for your Lifestyle® 5 music system. The speaker cables allow up to 20 feet (6.1 m) distance from the Acoustimass® module.



CAUTION: Choose a stable and level surface for your speakers. Vibration can cause the speakers to move, particularly on smooth surfaces like marble, glass, or highly polished wood. For additional stability, you can add rubber feet to your speakers. You may obtain rubber feet (part no. 178321), free of charge, from Bose®. Contact Bose Customer Service (see listings on the inside back cover).

1. For the most lifelike sound, place the cube arrays 6-12 feet (1.8-3.6 m) apart. They can be as close as 3 feet (1 m) or as far apart as 15 feet (4.6 m).
2. Direct one cube of each array forward. Direct the other cube toward the wall or in a different direction to create reflected sound. (See the illustration of reflected sound patterns in Figure 2.)



Note: The cube speakers are magnetically shielded so you can place them close to a TV without affecting picture quality.



Note: If you put the speakers in a bookcase unit, be sure to place each one at the front edge of the shelf. Placing speakers in an enclosed space can change the tonal quality of the sound. This effect is minimized if the shelves are filled with books.

Figure 2

Recommended speaker locations

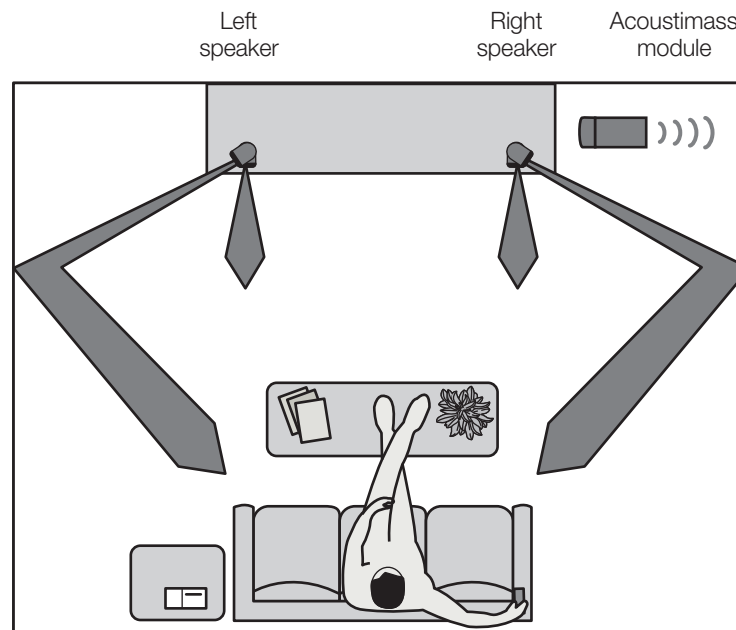

Acoustimass® module

Follow these guidelines to select a location for the Acoustimass module.

- Note:** To avoid interference with the TV picture, place the Acoustimass module at least 18 inches (45 cm) from a TV.
1. Place the module along the same the wall as the speakers, if possible (Figure 2).
 2. Select a convenient location – under a table, behind a sofa. Do not allow furniture or drapes to block the ventilation openings of the module.
 3. Place the module within reach of the audio input cable, speaker cables, and an AC power (mains) outlet.
 4. Select a position for the Acoustimass module (Figure 3). For proper ventilation, place it on the long edge, with the connectors facing the floor. An alternate position is on its largest side, with the bass and treble controls facing up. Do not place the module on either end, as shown by the last two views in Figure 3.

Figure 3

Acoustimass module positions

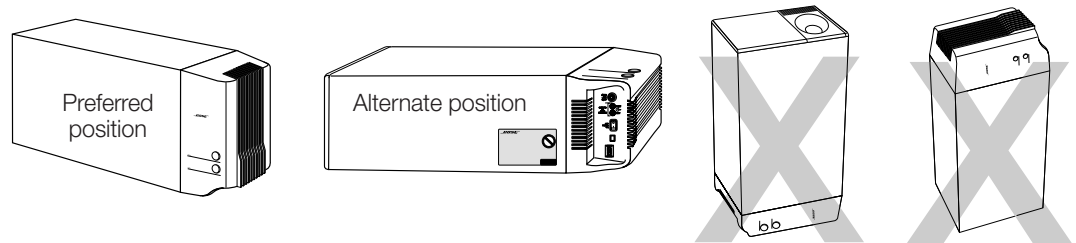

5. Once you have selected a position for the module, place the four self-adhesive rubber feet near the corners of the bottom surface. The rubber feet provide increased stability and protection from scratches.
6. Aim the port (the round opening) into the room or along the wall to avoid blocking the port or creating too much bass.
7. For best bass performance, do not place the port at equal distances from any two walls or from a wall and the ceiling.

CAUTION: Do not cover the ventilation openings of the Acoustimass module. The slots on the end provide ventilation for the built-in electronic circuitry, and should not be blocked.

Music center

Select a location for the music center.

1. Allow enough room to open the CD player cover.
2. Place the music center close enough to any additional sound sources (TV, VCR, etc.) to allow for cable length. If you need additional audio and/or video cables to connect all of your components, see your dealer or call Bose®.
3. Place the music center within 30 feet (9.1 m) of the Acoustimass module (the length of the audio input cable).

Note: Since some TVs can interfere with the proper operation of a CD player or tuner, you may want to avoid placing the music center directly on top of your TV.

Connect the speakers and Lifestyle® music center

Once you have selected locations for your music system, connect the speakers.

⚠ CAUTION: Make sure all components are unplugged from the power outlet before you begin hooking up the system.

Connecting the cube speaker arrays to the Acoustimass® module

Each speaker cable contains two wires. The wire marked with a red collar is positive (+) and the plain one is negative (-). These wires match the positive (red) and negative (black) terminals on the back of each speaker. To lengthen the cable, use standard RCA extension cables or splice in 18-gauge or thicker cord (connecting + to + and - to -). To purchase cables, see your dealer, electronics store, or call Bose® customer service.

1. Match the correct cable to the corresponding speaker location.
 - Speaker cables have blue connectors at one end, with L and R molded into the connectors.
 - The red collars on the + wire are labeled LEFT and RIGHT.
2. Connect the wire end of one speaker cable to the terminals on the rear of the matching cube speaker array.
 - a. Press the terminal tab on the back of the cube array to insert the marked wire into the red terminal and the plain wire into the black terminal. Release the tab to secure the wire.
 - b. Repeat this step for each of the cube speaker arrays. (See Figure 4.)

Figure 4

Speaker cable connections to the cube speaker array

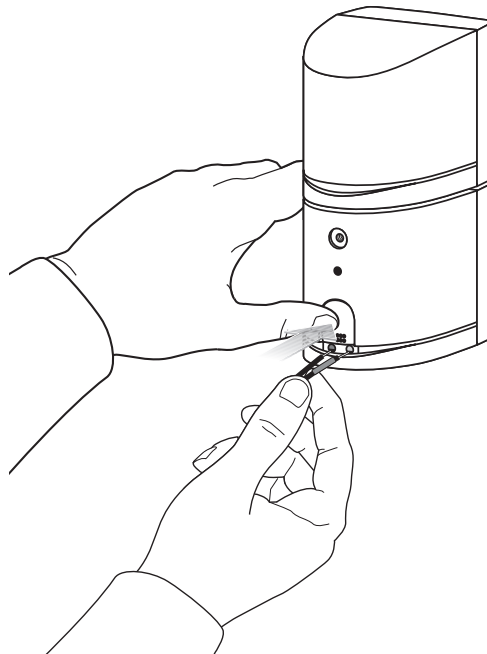

⚠ CAUTION: Make sure no strands of wire from any terminal touch any other terminal. Bridged wires create short circuits that affect proper operation of your system.

3. Connect each cable to the corresponding left or right blue jack on the Acoustimass module.

Connecting the Acoustimass® module to the Lifestyle® music center

Connect the Acoustimass module to the music center with the audio input cable (Figure 5).

1. Insert the three connectors at one end of the audio input cable into the jacks on the rear panel of the music center:
 - Black connector into the SYSTEM CONTROL 1 jack
 - Red connector into the R (right) SPEAKERS A OUTPUT jack
 - White connector into the L (left) SPEAKERS A OUTPUT jack

Note: Be sure the connectors are fully inserted into each of the jacks. If the black connector is not inserted fully into the SYSTEM CONTROL jack, you will hear no sound.

2. Insert the single right-angle multi-pin connector on the other end of the audio input cable into the AUDIO INPUT jack on the Acoustimass module. Align the connector at the angle shown in Figure 5.
3. Extend the audio input cable as much as possible, since it includes an antenna for the remote control.

Figure 5

Music center and speaker connections

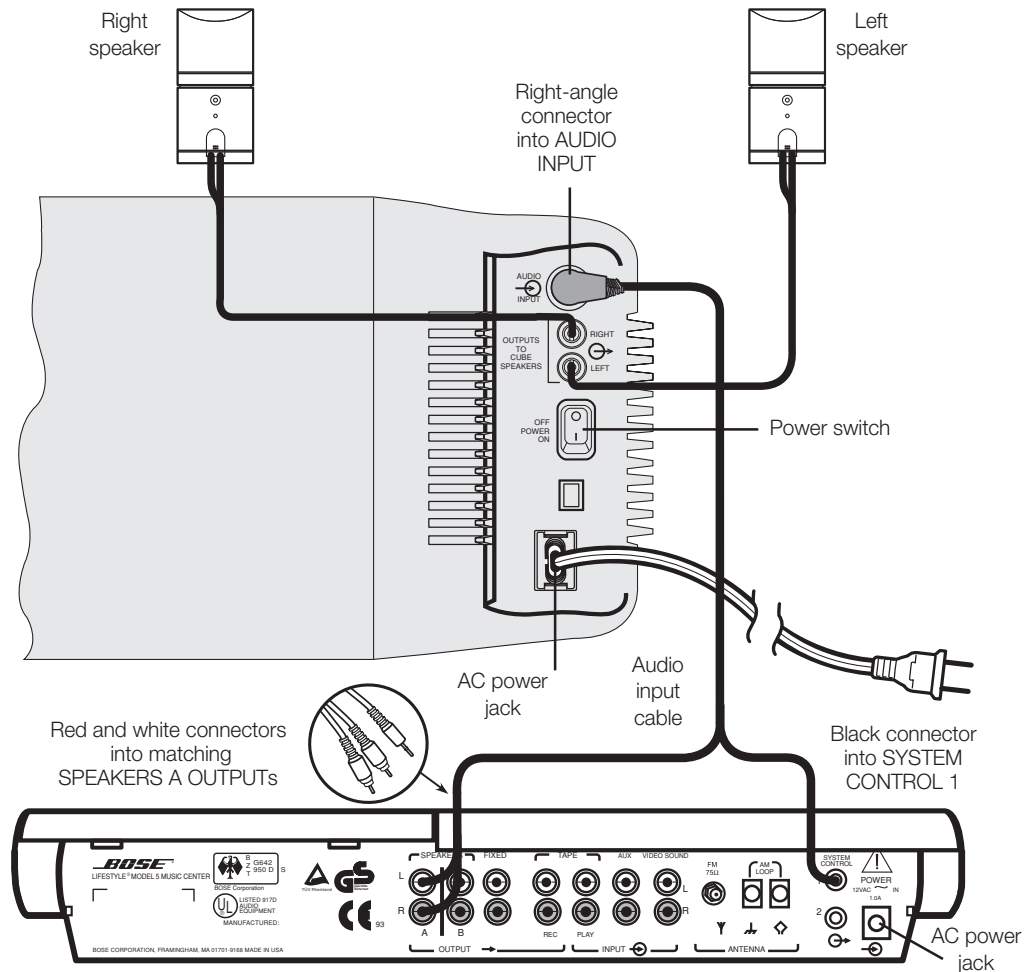

Connecting the Acoustimass® module power (mains) cord

1. On a dual voltage system, the voltage selector switch is preset at the factory to be correct for your area. Check to be sure it is set for the proper voltage (Figure 6). Use 115V for North America; 230V for Europe and Australia. Use the adapter plug provided when appropriate. If you are in doubt, contact your local electric utility for the appropriate voltage setting.

Figure 6

Dual voltage Acoustimass module: voltage selector switch settings

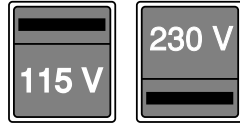

CAUTION: Make sure the voltage selector switch is set correctly.

2. Plug the small end of the power (mains) cord into the Acoustimass module AC power jack.



Note: Do **not** plug the AC power pack into a power outlet until all component connections are complete.

Connecting the music center AC (mains) power pack

The Lifestyle® music center comes with a 120V AC (mains) power pack for use in the USA and Canada or an appropriate 230V or 240V power pack for international use. (See Figures 1 and 7.) Dual voltage models include both 120V and 230V power packs.



CAUTION: Be sure to use the correct power pack for your area. Using the wrong one may damage your power pack or your music center.

- Model PS71, 120V in North America
- Model PS72, 230V in Europe
- Model PS74, 230V in UK or Singapore
- Model PS77, 240V in Australia

Figure 7

The AC power pack (model PS71 shown)

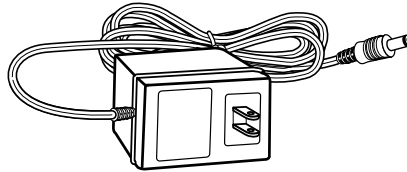

1. Firmly insert the small connector on the end of the AC (mains) power pack cable into the AC POWER jack on the back of the Lifestyle® music center.
2. Make sure that the power pack reaches an AC (mains) outlet.



Note: Do **not** plug the AC power pack into a power outlet until all component connections are complete.

Connecting other components to the Lifestyle® 5 music system

Use standard audio cables to connect other components to your Lifestyle® music system, matching the red connector to R (right) and white or black connector to L (left). For additional assistance with connecting other components, see your components manuals.

Figure 8

Music center connectors

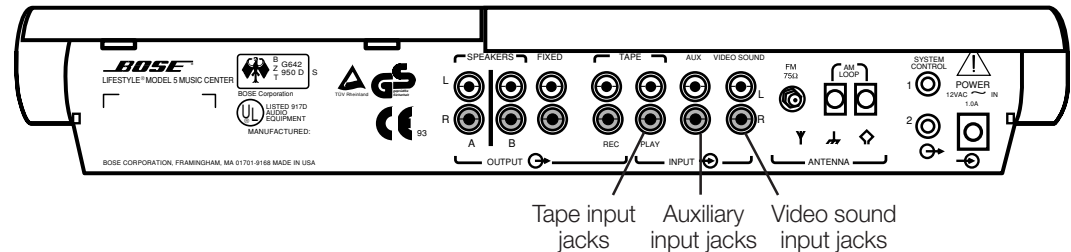

Video components

To play video sound through your Lifestyle® music system, connect the R and L audio outputs (fixed outputs preferred) of your stereo TV, stereo VCR, DVD, or laserdisc player to the music center VIDEO SOUND input jacks. You can use a Y-adaptor (available at electronics stores) to connect a mono source. However, the left and right speakers then play the same monaural sound.

Your TV is the display for the video (picture) signal. The video signal should not be connected to the Lifestyle® music system.

Note: To ensure proper stereo sound, connect the L and R audio outputs from your stereo VCR directly to your music center L and R VIDEO SOUND inputs.

If you prefer to connect the audio outputs from your TV to the music center, be sure to use the L and R audio outputs and the video output from the VCR to the TV, in addition to coaxial cable. Then, for proper playback of stereo-encoded video tapes, use the TV remote control to select the correct TV inputs (for example, change from "ANTENNA A" to "VIDEO 1" to receive the sound transmitted through the L and R connections). See your TV owner's manual for assistance.

Other connections

Tape deck

To use an external tape recorder (analog audio cassette, analog open reel, digital audio tape, Digital Compact Cassette, or MiniDisc), connect the inputs from the tape deck to the music center TAPE REC OUTPUT jacks. Connect the outputs from the tape deck to the music center TAPE PLAY INPUT jacks, matching the red plug to R (right) and black or white plug to L (left).

CD changer, CDI player, DVD player, or laserdisc player

To use one of these components, connect its audio outputs to the music center AUX INPUT jacks, matching the red plug to R (right) and black or white plug to L (left).

Turntable

To connect a turntable, you may need a phono preamplifier (with RIAA equalization). Consult your dealer for the appropriate model. Connect the audio outputs of the phono preamplifier to the music center AUX INPUT jacks, matching the red plug to R (right) and black or white plug to L (left).

Note: The Lifestyle® music system cannot turn a connected component on or off.

Connect the antennas

The rear panel of your Lifestyle® music center provides connections for AM and FM antennas (Figure 9). Unwind each antenna's wires. Antennas provide better reception when their wires are not bundled.

Figure 9

The antenna connections

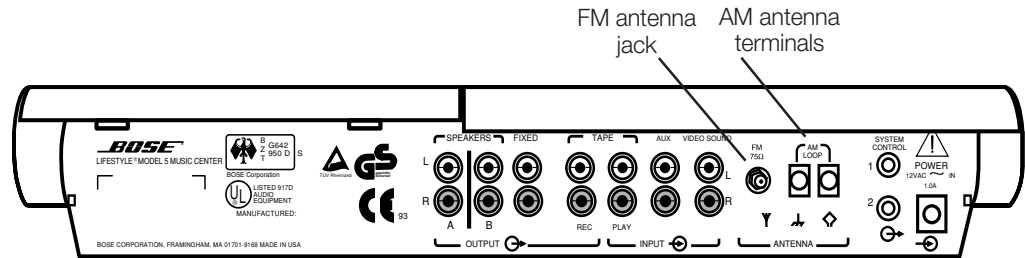

Figure 10

The FM dipole antenna



FM antenna connections

1. Plug the antenna connector into the FM ANTENNA jack on the back of the Lifestyle® music center.
2. Spread out the antenna arms. Experiment with both the placement and the angle of this antenna to provide optimum FM reception.

AM antenna connections



Note: To install the AM antenna on a wall, follow the instructions enclosed with the antenna.

1. Loosen the AM ANTENNA screw terminals on the back of the Lifestyle® music center.
2. Slide the wire connectors around the screw terminals. Tighten the screws over the connectors.
3. Stand the loop antenna on the base, following the instructions enclosed with the antenna.
4. Move the loop part of the antenna at least 20 inches (50 cm) from the music center. Experiment with the orientation of the loop for optimum AM reception.



Note: Outdoor antennas may be used with the music center antenna connections. To install an outdoor antenna, consult a qualified installer. Follow all safety instructions.

Figure 11

The AM loop antenna

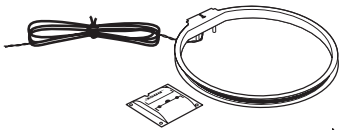

Connecting to a cable radio signal

To connect your system to the FM signal available from some cable TV companies, contact your cable provider for assistance. The connection is made to the FM 75Ω EXTERNAL antenna connector on the back of the system.



CAUTION: Be certain that the installation includes a signal splitter so that only the FM band, not the cable TV band, is transmitted to the system. It is necessary to use a splitter that filters the signal to prevent any re-emissions of the TV spectrum through the system.

Attach the wire cover

To hide the wires and jacks from view, after all the connections are completed, attach the wire cover to the music center. The five tabs on the wire cover snap into matching slots on the music center back panel.

Figure 12

The wire cover

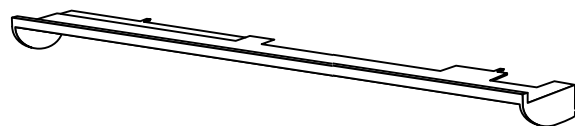

Set up the remote control

Install the batteries

1. Slide open the battery compartment on the back of the remote (Figure 13).
2. Insert 3 AA or IEC-R6 1.5V batteries, or the equivalent, as shown. Match the + and – symbols on the batteries with the + and – markings inside the compartment.
3. Slide the battery compartment cover back into place.

Replace the batteries when the remote control stops operating or its range seems reduced. Alkaline batteries are recommended.

Note: Do not change the settings of the factory-preset miniature switches. See “Changing the house code settings” on page 19 for information on how to prevent conflicts with other Lifestyle® music systems.

Figure 13

Installing the remote control batteries

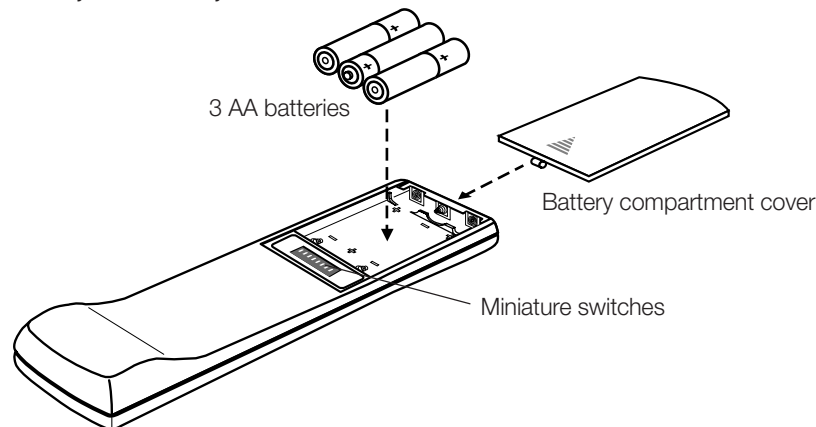

Set radio channel spacing for dual voltage and 120V systems

Dual voltage music centers (which include both 120V and 230V power packs) and 120V music centers can be set for two types of AM and FM channel spacing.

- Channel spacing for North America is 10 kHz for AM and 200 kHz for FM.
- Channel spacing for Europe is 9 kHz for AM and 50 kHz for FM.

Your dual voltage or 120V music center is factory preset for North American spacing. Select the channel spacing most appropriate for your area.

To change AM and FM channel spacing:

1. Press OFF to turn off the music system.
2. Press and release the ERASE key under the CD cover. (See Figure 15 on page 15.)

The display indicates US for North American spacing and EU for European spacing.

Turn on the music system

Plug the Acoustimass® module power cord into an AC (mains) outlet. Then plug in the music center power pack. Turn the power switch on the module connection panel to the ON (I) position. We recommend you leave this switch on. The module uses less than 2 watts of electricity in standby mode (less than an average night light).

Note: Your speakers will not operate unless you complete all cable and power connections before turning on the music center.

Note: If your system will be unattended for a few days, you may want to unplug your music center to prevent a neighbor's Lifestyle® remote control or your pets from accidentally turning it on. In addition, see “Changing the house code settings” on page 19.

You are ready to enjoy your new Lifestyle® system. Refer to the following pages for information on operating the music center controls and the Lifestyle® remote control.

The music center display

This music center display (Figure 14) provides information on the music center functions.

Figure 14

The music center display

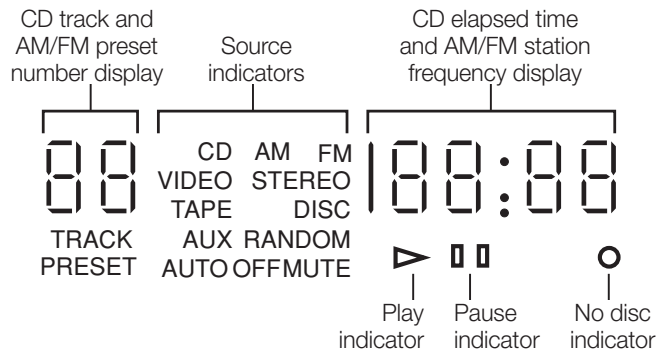

The system controls

Function

Remote Control

Music Center

AUX - Selects a CD changer or other component connected to the AUX inputs, and turns the system on.



VIDEO - Selects a video sound source connected to the VIDEO inputs, and turns the system on.



TAPE - Selects a tape deck or component connected to the TAPE inputs, and turns the system on.



AM/FM - Selects the radio and turns the system on. When the radio is on, switches between AM and FM.



CD - Selects the built-in CD player and turns the system on.

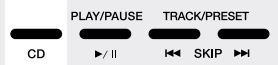

▶/|| PLAY/PAUSE - Begins or pauses play of the CD. When held down for two seconds, stops play of a CD.



◀◀▶▶ SKIP - Selects the previous or next CD track, or the previous or next preset radio station.

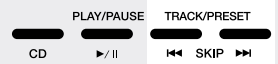

◀◀▶▶ SKIP - Press and hold to scan a CD. When these two keys on the music center are pressed simultaneously, plays CD tracks in random order.

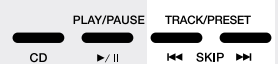

◀◀▶▶ SEEK - Searches backward or forward through a CD. Seeks the previous or next strong AM or FM station.

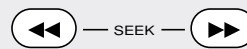

VOLUME ▲ \ ▼ - Raises or lowers the system volume.



AUTO OFF - Sets a 15-minute delay before the system shuts off. Each additional key press increases the time until shutoff by 15 minutes (up to 75 minutes).



MUTE - Silences the speakers. Also restores volume to muted speakers.



OFF - Turns the system off.



Figure 15

The music center controls

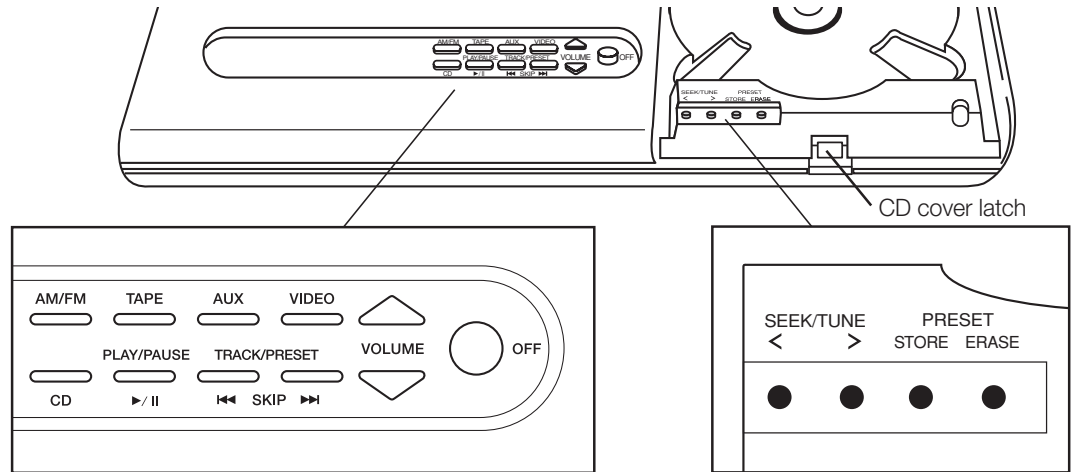

The music center controls

Use the special keys on the music center to manually tune the radio and set station presets. The CD cover latch opens the CD cover for loading and unloading a CD.

SEEK/TUNE < / > - Lowers or raises the frequency setting of the radio (stations).

PRESET STORE/ERASE - Adds or removes radio station presets.

The Lifestyle® remote control

Figure 16

The remote control

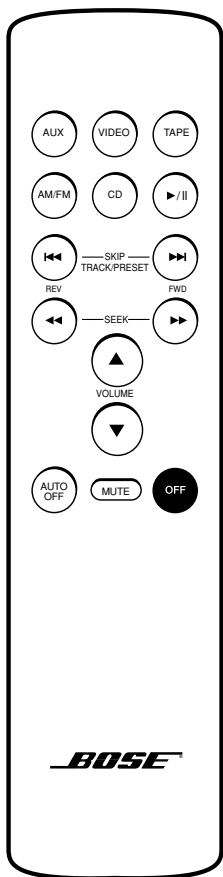

🎵 **Note:** Some types of buildings create “dead spots” where the remote will not operate. Simply move the remote a foot or two and try again. You can also move the music center a few feet to a location with better remote response.

Listening to the radio

Turning the system on and choosing the radio

Press the AM/FM key on the remote or the console to turn your music system on to the most recently heard AM or FM station.

♪ **Note:** If the system is on and the radio is already selected, this key switches between the AM and FM bands.

Tuning

Seeking the strongest stations

- Press and release the SEEK ►► (forward) or ◀◀ (reverse) key on the remote to seek and stop at the next strong signal. If you hold these keys down, the radio continues to seek without stopping at any station.
- Or, press SEEK/TUNE > or < (under the CD cover) on the music center.
- To stop seeking in one direction, briefly press the opposite direction key.

Switching between AM and FM

Press the AM/FM key to switch to the other band.

Manual tuning

If you want to tune the radio to a distant or weak station that the radio cannot seek, use the SEEK/TUNE keys, located under the CD cover.

1. Hold down the > or < key to scan through the stations.
2. Release the > or < key to stop at a selected station.
3. As soon as the scan stops, tap the > or < key to tune one channel at a time.

Setting a station preset

Your Lifestyle® music center can store up to 20 AM and FM stations in any combination.

1. Select a radio station you wish to store as a preset.
2. Press the STORE key (located under the CD cover). The station is stored in the lowest available preset location.
3. If you decide not to store the displayed station in the displayed preset location:
 - a. Press and hold the STORE key.
 - b. Press the SKIP ►► (forward) or ◀◀ (reverse) key to select a different preset number for this station.
 - c. Release the STORE key. The frequency of the preset station flashes.

♪ **Note:** You cannot store a station in an already-occupied preset location without erasing that preset station first (see "Erasing a preset station" below). If you attempt to store more than 20 stations, the preset display will flash '— —'.

Selecting a preset station

Once you set one or more station presets, press the SKIP ►► (forward) or ◀◀ (reverse) key to select the next or the previous preset station.

Erasing a preset station

1. Use the SKIP ►► (forward) or ◀◀ (reverse) keys to select the preset station you wish to erase.
2. Press the ERASE key (located under the CD cover). The preset number is no longer lit.

Listening to a CD

Loading a CD into the music center

Press the latch on the CD cover, and place a CD onto the spindle, label-side up. Close the CD cover.















Turning the system on and choosing the CD player

Press the CD key on the remote or the console. If the music system is already on, pressing one of these keys selects the CD player and the CD indicator lights.

If a CD has been loaded, it begins to play. If no CD is loaded, the No Disc  indicator lights.

Using the CD player

The following operations apply to keys on both the remote control and the music center, except where noted:

- To play a stopped or paused CD, press   PLAY/PAUSE.
- To pause a CD, press  .
- To stop a CD, hold the   key on the music center for two seconds, press the  STOP key on the remote, or open the CD cover.
- To skip tracks, press SKIP  (forward) to go to the next track or SKIP  (reverse) to go to the beginning of the current or previous track.
- To move through a track, on the remote control press SEEK  (forward) to move forward or SEEK  (reverse) to move back, on the music center press and hold SKIP  or SKIP .
- To play tracks in random order, (using the music center controls only) press the SKIP  and  keys simultaneously. To continue playing the tracks in their regular order, press these keys again.

Using the system with an external component

Follow the instructions for connecting a component before proceeding. To begin, make sure the component is turned on and a tape, CD, CDI, DVD, laserdisc, etc. is loaded.



 **Note:** *The Lifestyle® 5 music system cannot turn a connected component on or off.*

Turning the system on and selecting the component

Press the TAPE, AUX, or VIDEO key on either the remote or the console to turn the system on and select the component connected to that input. If the system is already on, press one of these keys to select the component.

The appropriate display indicator lights when the system is on and the component is selected.

Using a tape deck, CD changer, or other connected component

Turn on your component directly or by using its remote control. Use the VOLUME  (up) or  (down) key to raise or lower the volume. Control all other functions at the source, referring to its owner's manual if necessary. To record to a connected tape deck, play the source (AM/FM, CD, AUX, VIDEO) you wish to tape. Set the tape unit to record.

Using headphones

For headphone listening, use the stereo mini headphones  jack on the left side of the music center. While this jack accepts most headphone models, you can get an adapter at Bose® dealers and most electronics stores, if needed. Connecting headphones automatically shuts off speakers connected to SPEAKERS A and FIXED OUTPUTS.

Fine-tuning your system

Figure 17

Bass and treble controls

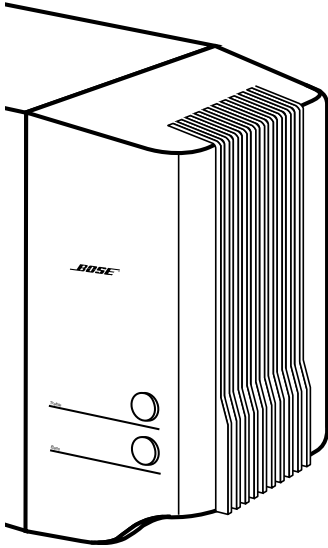

In most situations, you only need to follow the speaker placement guidelines (see “Setting Up” on pages 6-7) for your system to provide excellent sound quality.

You do not need to adjust tone settings for changes in volume, since Bose® patented signal processing technology provides a natural tonal balance over the full range of volume settings.

If desired, you can further fine-tune your system as described here.

Adjusting speaker controls

The Lifestyle® 5 music system TREBLE and BASS controls are located on the Acoustimass® module (Figure 17). They allow you to adjust the treble (high frequencies) and bass (low frequencies). In the normal setting, the dots on each control are in the 12 o'clock position. You can also locate the normal setting by feeling when the control settles into the notch at this position. Turn the controls clockwise to increase, and counterclockwise to decrease, the amount of treble or bass.

Compensating for room acoustics

The acoustics (sound qualities) of your room can affect the overall sound quality of any speaker system. In general, you can reduce many problems with acoustics by the cautious use of the TREBLE and BASS controls.

Too much or too little treble

Rooms with too few sound-absorbing furnishings, especially those with bare floors and walls, may sound overly shrill or “bright.” Turning down the treble control (toward –) decreases treble sound.

Rooms with a lot of sound-absorbing furnishings, such as upholstered furniture, wall-to-wall carpet, or heavy drapes, may reduce the treble sound of your system. Moving speakers further away from soft furnishings increases treble. You can increase treble sound by slightly turning up the treble control (toward +).

Too much or too little bass

You can decrease bass sound by turning down the bass control (toward –). To increase bass, turn up the bass control (toward +).

Acoustimass module placement affects the amount of bass you hear. Placing the module closer to the corner of the room increases bass. Moving the module away from the corner decreases bass.

Changing the house code settings

Each Lifestyle® remote control uses a system of matching house codes to communicate with its corresponding music center. If your remote's commands ever conflict with those of another nearby Lifestyle® system, you can easily set a new house code for your system and its remote control(s) by following the procedures below.

1. Open the remote control battery cover.
2. Locate the miniature switches (Figure 22). Change the position of switch 2, 3, or 4 by moving it in the opposite direction from its current setting.

♪ **Note:** Do not change any other switches at this time.

3. Replace the battery cover on the remote control.
4. Press the OFF key on the console.
5. Open the CD cover.
6. Press the STORE key. The display will begin to flash '— —'.
7. Within two seconds while the display is flashing, press any key on the remote control.

The display stops flashing and momentarily shows '— —' to confirm recognition of the house code. The system will remain off.

8. If you have additional remote controls, open the battery cover of each one and change the switches to match those of the first remote control. It is not necessary to repeat steps 4–7.

Figure 22

Miniature switches for setting house codes and speakers

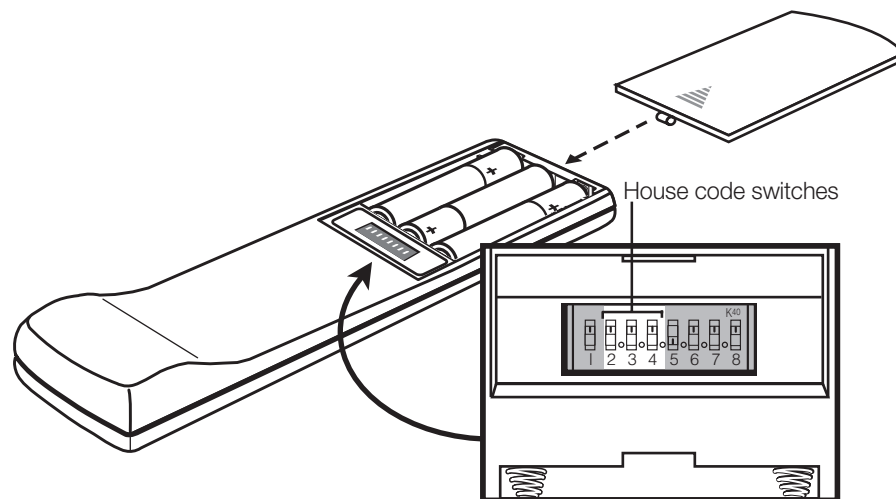

Adding speakers

Your Lifestyle® 5 music system provides high quality audio for a single listening area. However, your music center also provides connections (SPEAKERS B) for adding a pair of powered speakers in a second room. In the second room, you can listen to the sound source that is playing in the main room.

You can purchase an additional remote control to keep in the second room.

Keep the following considerations in mind if you choose to connect secondary speakers.

Using speakers connected to the B outputs:

- You must use a second remote control, set to B (see instructions below), to turn on the B speakers.
- Adjusting volume with this second remote adjusts volume for only the B speakers.
- Using the mute key on the second remote mutes or unmutes the second room speakers.

Using speakers connected to the A and/or FIXED outputs:

- The music center controls operate speakers connected to A and FIXED outputs.
- Adjusting volume from the music center control panel or with the remote control that came with the system adjusts volume for speakers connected to A and FIXED outputs.
- Using the mute key on the main remote mutes or unmutes speakers connected to A and FIXED outputs.

Setting a second remote for additional speakers

You need a second remote control, set to B, to operate speakers connected to the SPEAKERS B outputs. When you purchase a second remote control, it is shipped set to A, to control your main speakers. It will also control secondary speakers connected to FIXED outputs.

To set your second remote to control speakers connected to B, follow these steps:

1. Open the remote control battery cover.
2. Locate miniature switch 5. Slide the switch down (Figure 23).
3. Locate miniature switch 6. Slide the switch up (Figure 23).
4. Make sure that the house code switches match those on your first remote (see page 20).
5. Replace the battery cover on the remote control.

Note: Switches 7 and 8 are not for current system use.

Figure 23

Speaker code switch settings



Set to SPEAKERS A

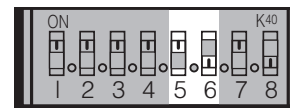

Set to SPEAKERS B

Troubleshooting

Problem	What to do
System does not function at all	<ul style="list-style-type: none"> • Make sure the power connector is plugged securely into the music center, the Acoustimass® module power cord is plugged securely into the module, the power pack and power cord are plugged into operating AC wall outlets, and the module power switch is on. • Be sure to select a source (CD, AM/FM, etc.). • Unplug the music center power pack for a minute, then reconnect it. This allows the unit to reset itself after a power surge or power interruption.
No sound	<ul style="list-style-type: none"> • Make sure the audio input cable is connected to the music center SPEAKERS A outputs, the black connector is fully seated in the music center SYSTEM CONTROL 1 jack, and the multi-pin connector is firmly seated in the Acoustimass module jack. • Make sure the module power switch is in the ON position. • Turn the music center off for ten seconds, then on again, to reestablish communication between the music center and the speakers. • Check the connections for any external components. Make sure to select the correct source for the desired input. • Check the speaker connections. • Be sure the CD is placed correctly, label-side up, in the music center, and the cover is closed. • Increase the volume. • Check to see if MUTE is lit in the display. Press MUTE on the remote to unmute the sound. • Disconnect any headphones. • Connect the FM and AM antennas.
Remote control is inconsistent or does not work	<ul style="list-style-type: none"> • Check batteries and their polarity (+ and -). • Operate the remote control closer to the music center. • Make sure the remote control house code matches the music center code. Follow steps 4-7 on page 19 to match the house code settings.
Unit turns on and off by itself, or acts erratically	<ul style="list-style-type: none"> • Change the house code setting to prevent signals from conflicting with another nearby Lifestyle® system. See page 19 for instructions on setting the house code.
CD does not play	<ul style="list-style-type: none"> • Make sure the music center CD cover is closed. • Check to see if the play symbol ► in the display is lit. • After pressing the CD key, wait a few seconds before pressing PLAY. • Check to see if there is a disc in the player, label-side up. • The disc may be damaged. Try another disc. • There may be dirt or dust on the laser pickup or on the CD. Clean the CD. Do not touch the laser pickup. • The music center cannot play a DVD disc.
Radio does not work	<ul style="list-style-type: none"> • Make sure antennas are connected properly. • Adjust antenna position to improve reception. • You may be in an area of weak signal coverage.
FM sound is distorted	<ul style="list-style-type: none"> • Adjust antenna position to reduce interference.
Sound is distorted	<ul style="list-style-type: none"> • Make sure speaker cables are not damaged and the connections are secure. • Reduce the output level from any external components connected to the music center.
No tape, CD, VCR, or TV sound	<ul style="list-style-type: none"> • Check the connections. • Refer to the component owner's manual.

Warranty period

The Bose® Lifestyle® 5 music system is covered by a limited 1-year transferable warranty. Details of the warranty are provided on the warranty card that came with your system. Please fill out the information section on the card and mail it to Bose.

Customer service

For additional help in solving problems, contact Bose customer service. See the inside back cover for Bose customer service offices and phone numbers.

Cleaning the Lifestyle® 5 music system

The only maintenance needed is cleaning the system and replacing batteries for the remote control.

For information on replacing the remote control batteries, see “Install the batteries” on page 13.

Cleaning the music center

Use only a soft cloth to clean the outside of the Lifestyle® music center.

Do not use any solvents, chemicals, or cleaning solutions containing alcohol, ammonia, or abrasives. Do not allow liquids to spill into any openings. Do not use any sprays near the system.

Cleaning the CD player lens

Clean the CD player lens carefully, and only if necessary. If the lens is dusty, blow the dust away using a cold blower or camera lens brush. To remove fingerprints from the lens, wipe it gently with a lens tissue moistened with lens cleaning solution. Make sure no solution enters the unit; it may cause damage.

 **Note:** Do **not** apply excessive pressure on the lens, which could be damaged.

Cleaning the speakers and Acoustimass® module

Clean the surface of your speakers with a soft damp cloth. Do not use any sprays near the system. Do not use any solvents, chemicals, or cleaning solutions containing alcohol, ammonia, or abrasives. Do not allow liquids to spill into any openings.

The speaker grille panels require no special care, although you may vacuum them carefully with a soft-bristled attachment, if necessary.

 **CAUTION:** If liquids get into the product, turn the system off and allow it to air dry. Then turn it on again. If you notice any problems with its functioning, turn it off and contact Bose® customer service.

Technical information

Powered Acoustimass® 5 speaker system

Power rating

USA/Canada: 120V~ 50/60 Hz 350W

Europe/Australia: 220-240V~ 50/60 Hz 350W

Dual Voltage: 115/230V~ 50/60 Hz 350W

Model 5 music center

Power pack power rating

USA/Canada: 120V~ 60 Hz 25VA

Europe: 230V~ 50 Hz 25VA

Australia: 240V~ 50 Hz 25VA

Dual Voltage: 120V~ 60 Hz 25VA and
230V~ 50 Hz 25VA

Inputs

TAPE: 3V maximum

AUX, VIDEO SOUND: 4V maximum

FM antenna: 75Ω

AM antenna: 12 μH

POWER: 12V~, 1.0 A

Outputs

Variable audio: SPEAKERS A and B

Fixed audio: FIXED, TAPE

Headphone: 32Ω minimum impedance

SYSTEM CONTROL: for use with Bose®
powered speakers and accessories

RC-5 remote control

Range: 65 feet (20 m)

Dimensions

Music center

15.0" W x 7.8" D x 2.5" H
(38.1 cm x 19.8 cm x 6.4 cm)

Cube speakers

3.1" W x 4.0" D x 6.2" H
(7.8 cm x 10.2 cm x 15.7 cm)

Acoustimass module

23.3" W x 7.5" D x 14.0" H
(59.0 cm x 19.0 cm x 35.5 cm)

Weights

Music center

4.0 lb (1.7 kg)

Cube speakers

2.4 lb (1.1 kg)

Acoustimass module

33 lb (15.0 kg)

Total shipping weight

50 lb (22.7 kg)

Finish

Music center

Simulated aluminum, Polymer

Cube speakers

Polymer, painted

Acoustimass module

Vinyl veneer, Polymer

Accessories

To find out about mounting brackets, stands, and additional remote controls, contact your Bose dealer. Or call Bose directly (see inside back cover for phone numbers).

A

Acoustimass® module 2-10, 13, 18, 21, 23
 AM antenna 5, 12, 21, 23
 AM/FM 4, 14, 16, 17, 21
 ANTENNA 12
 antenna 5, 12, 21, 23
 audio input cable 5, 7, 9, 21
 AUTO OFF 14
 AUX 14, 17, 23
 auxiliary 4

B

BASS control 18
 batteries 5, 13, 21, 22

C

cable 5-9, 10, 21
 cable radio signal 12
 cable TV 12
 CD 4, 7, 14, 15, 16, 17, 19, 21, 22
 CD player cover 7
 CDI player 11, 17
 compact disc 17
 connections 8-12, 20, 21
 controls 2, 7, 14, 15, 18, 19, 23
 cube speakers 6, 8, 23
 customer service 5, 8, 22

D

display 11, 14, 16, 17, 19, 21
 DVD 11, 17, 21

E

external antenna 12

F

FM 75Ω EXTERNAL antenna connector 12
 FM antenna 5, 12, 23

H

headphones 17, 21
 house codes 13, 19, 20, 21

L

laserdisc 11

M

moisture 2
 music center 2-5, 7-17, 19-22
 MUTE 14

P

placement 6, 12, 18
 PLAY 14
 port 7
 power cord 5, 10, 13, 21
 power pack 5, 10, 13, 21, 23
 PRESET 14-16
 preset radio station 14-16

R

radio 4, 14, 15, 16, 21
 radio channel spacing 13
 RCA extension cables 8
 red collar 8
 remote control 3, 4, 13, 15, 17, 19, 20-23
 room compensation controls 18

S

safety information 2
 serial numbers 5
 signal splitter 12
 speaker cable 5-8, 21
 switches 13, 14, 16, 19, 20

T

TAPE jack 11, 17
 tape deck 4, 11, 14, 17
 terminals 8
 TREBLE control 18
 troubleshooting 21
 tuning 16
 turntable 11
 TV 6, 7, 11, 12, 21

U

unpack 3, 5

V

VCR 7, 21
 ventilation 7
 VIDEO SOUND jack 11, 14, 23
 voltage 2, 5, 10, 23
 VOLUME 14
 volume 14, 17, 18, 20, 21

W

warranty 22
 wire cover 5, 12

USA

Bose Corporation, The Mountain
Framingham, MA 01701-9168
1-800-288-BOSE (1-800-288-2673)
Phone hours - ET (eastern time):
Weekdays 9 a.m. to 8 p.m.
Saturdays 9 a.m. to 3 p.m.

Canada

Bose Ltd., 1-35 East Beaver Creek Road
Richmond Hill, Ontario L4B 1B3
1-800-444-BOSE (1-800-444-2673)
Phone hours - ET (eastern time):
Weekdays 9 a.m. to 5 p.m.

European Office

Bose B.V., Nijverheidstraat 8
1135 GE Edam, Nederland
TEL 0299-390190 FAX 0299-390109

Australia

Bose Australia, Inc., 1 Sorrell Street
Parramatta, N.S.W. 2150
TEL 02 204-6111 FAX 02 204-6122

Belgique/België

Bose N.V., Limesweg 2, B-3700 Tongeren
TEL 012-390800 FAX 012-390840

Danmark

Bose A/S, Industrivej 7, 2605 Brøndby
TEL 4343-7777 FAX 4343-7818

Deutschland

Bose GmbH, Max-Planck-Straße 36d
D-61381 Friedrichsdorf
TEL 06172-71040 FAX 06172-710419

France

Bose S.A., 6, rue Saint Vincent
78100 Saint Germain en Laye
TEL 01-30616363 FAX 01-30614105

India

Bose Corporation India Private Limited
W-16, Greater Kailash-II
New Delhi 110 048
TEL (011) 648 4462 FAX (011) 648 4463

Ireland

Bose Corporation
Carrickmacross, Co Monaghan
TEL 042-61988 FAX 042-61998

Italia

Bose S.p.A., Via della Magliana 876
00148 Roma
TEL 06-65670802 FAX 06-65680167

Japan

Bose K.K., Shibuya YT Building
28-3 Maruyama-cho
Shibuya-ku, Tokyo 150
TEL 3-5489-0955 FAX 3-5489-0592

Nederland

Bose B.V., Nijverheidstraat 8
1135 GE Edam
TEL 0299-390111 FAX 0299-390109

Norge

Bose A/S, Solheimsgate 11
N-2001, Lillestrøm
TEL 63-817380 FAX 63-810819

Österreich

Bose Ges.m.b.H., Vienna Business Park
Wienerbergstrasse 7 (10.OG)
A-1100 Vienna
TEL 01-60404340 FAX 01-604043423

Schweiz

Bose AG, Rünenbergerstrasse 13
4460-Gelterkinder
TEL 061-9815544 FAX 061-9815502

Sverige

Bose A/S, JohanneFredsgatan 4
S-43153 Mölndal
TEL 31-878850 FAX 31-274891

United Kingdom

Bose Limited, Unit G2
Trinity Trading Estate
Sittingbourne, Kent ME10 2PD
TEL 01795-475341 FAX 01795-427227

From other locations

Bose Customer Service, 1 New York Ave.
Framingham, MA 01701-9168 USA
TEL (508) 766-1900 FAX (508) 766-1919

World Wide Web

www.bose.com

BOSE[®]
Better sound through research[®]

©2001 Bose Corporation
The Mountain, Framingham, MA 01701-9168 USA
251174 AM Rev.03 JN20413